



Aiming to avoid human error in  
**Diagnostic Testing?**



**FlexLab™**  
100% open, **scalable** and  
with **full sample traceability**

# FlexLab™

Open automation, **packed with innovation.**

- Would you like to connect various specialties from different analyzer manufacturers?
- Do you believe that cutting-edge innovation advances healthcare?
- Are you looking for an automation system that grows with your needs?

Inpeco's FlexLab™ Total Laboratory Automation system is built for laboratories looking for **a game-changing, open system solution** that is future proof and drives premium quality patient care.

Laboratory Managers face the daily challenge of delivering accurate test results in the shortest possible turnaround times, increasing productivity, improving quality and motivating their professional staff, whilst respecting regulatory requirements and tight budgets. FlexLab™ is designed to meet these challenges in a compelling way.

## What makes FlexLab™ unique?

### Open connectivity

FlexLab™ is the only truly open automation system that allows laboratories to connect the analyzers of their choice and the specialties they need → **100% independence**

### Full traceability of the single tube journey

FlexLab™'s powerful software determines the optimal processing path for every single tube and provides seamless tracking of the identified tube until its disposal → **100% tube control**

### Scalable solution

FlexLab™ grows with your needs, at the time you decide and in the way you prefer. Adding modules or new analyzer connections is easy by design → **100% future ready**

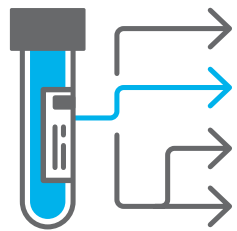

**50+**  
**ANALYZER**  
**CONNECTIONS**

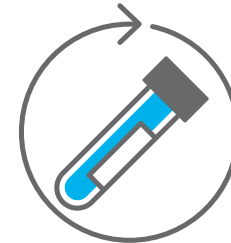

**THROUGHPUT**  
**UP TO**  
**10.000 TUBES**  
**PER HOUR**

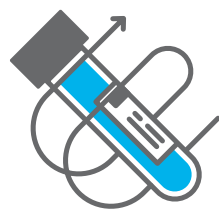

**OVER 20**  
**PRE- AND**  
**POST-ANALYTICAL**  
**MODULES**

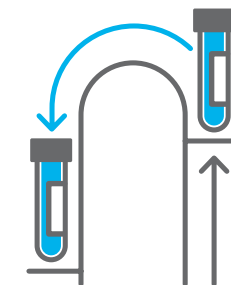

**VERTICAL**  
**TRANSPORTATION**  
**FOR EXPANDING**  
**LABS IN 3D**

# Project Design: the way to **your tailor-made solution**

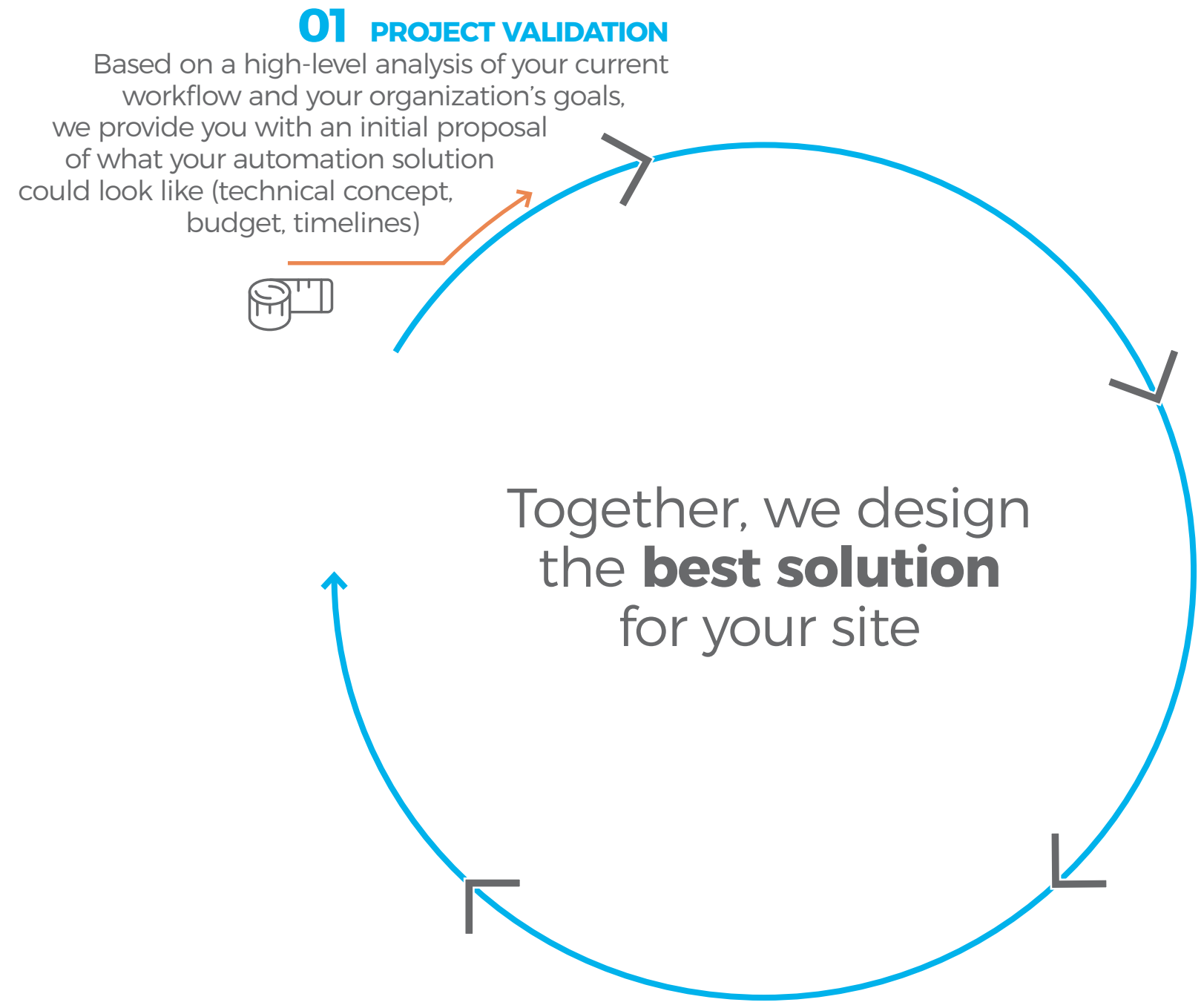

Designing an automation solution around your needs is easier than you think, when you partner with the global leader in Total Laboratory Automation. Following an in-depth analysis of your current workflow and your key requirements, our **Customer Solution Specialists** design a game-changing automation solution for you, in just four steps.

# Project Design: the way to **your tailor-made solution**

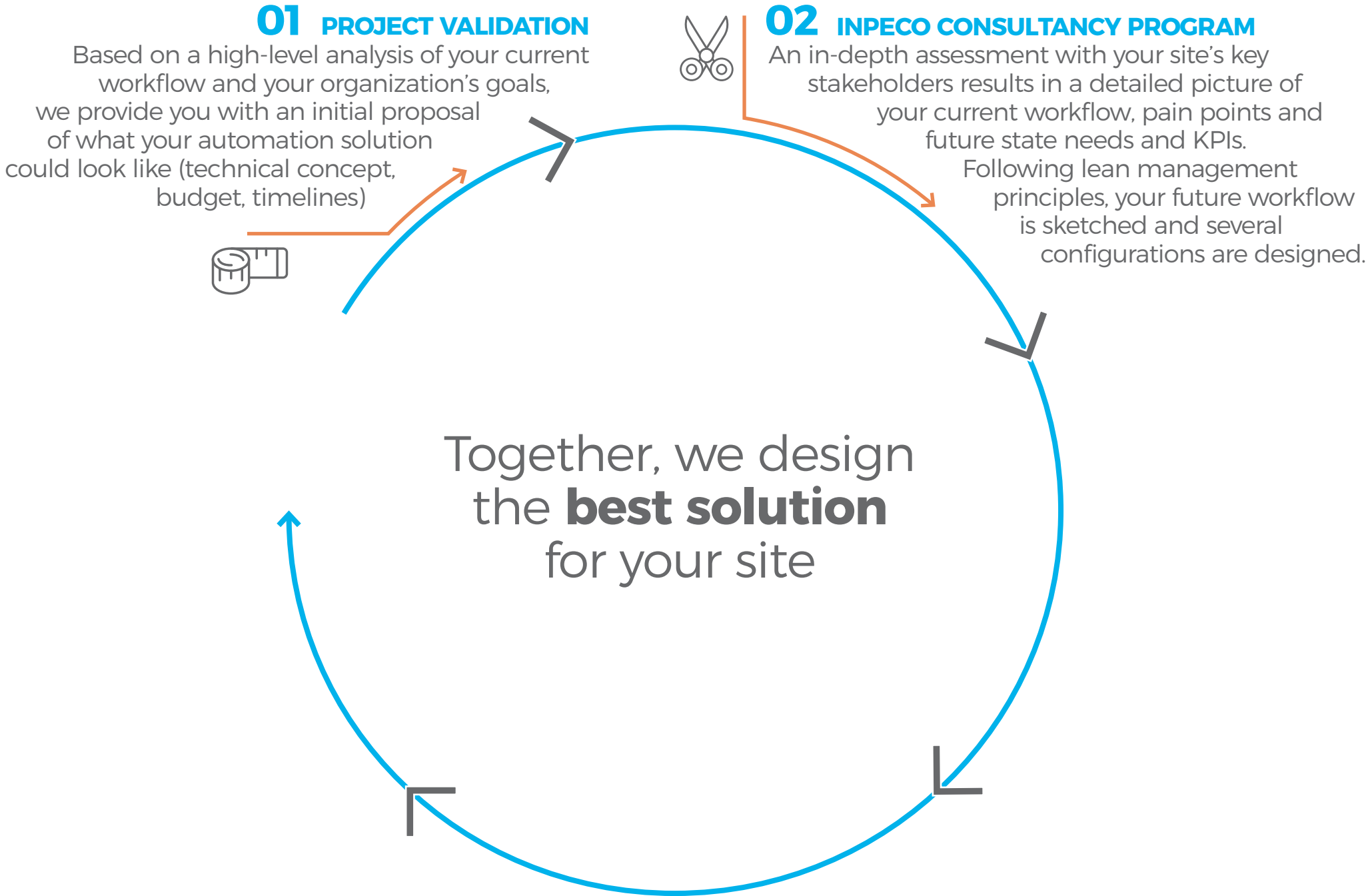

# Project Design: the way to **your tailor-made solution**

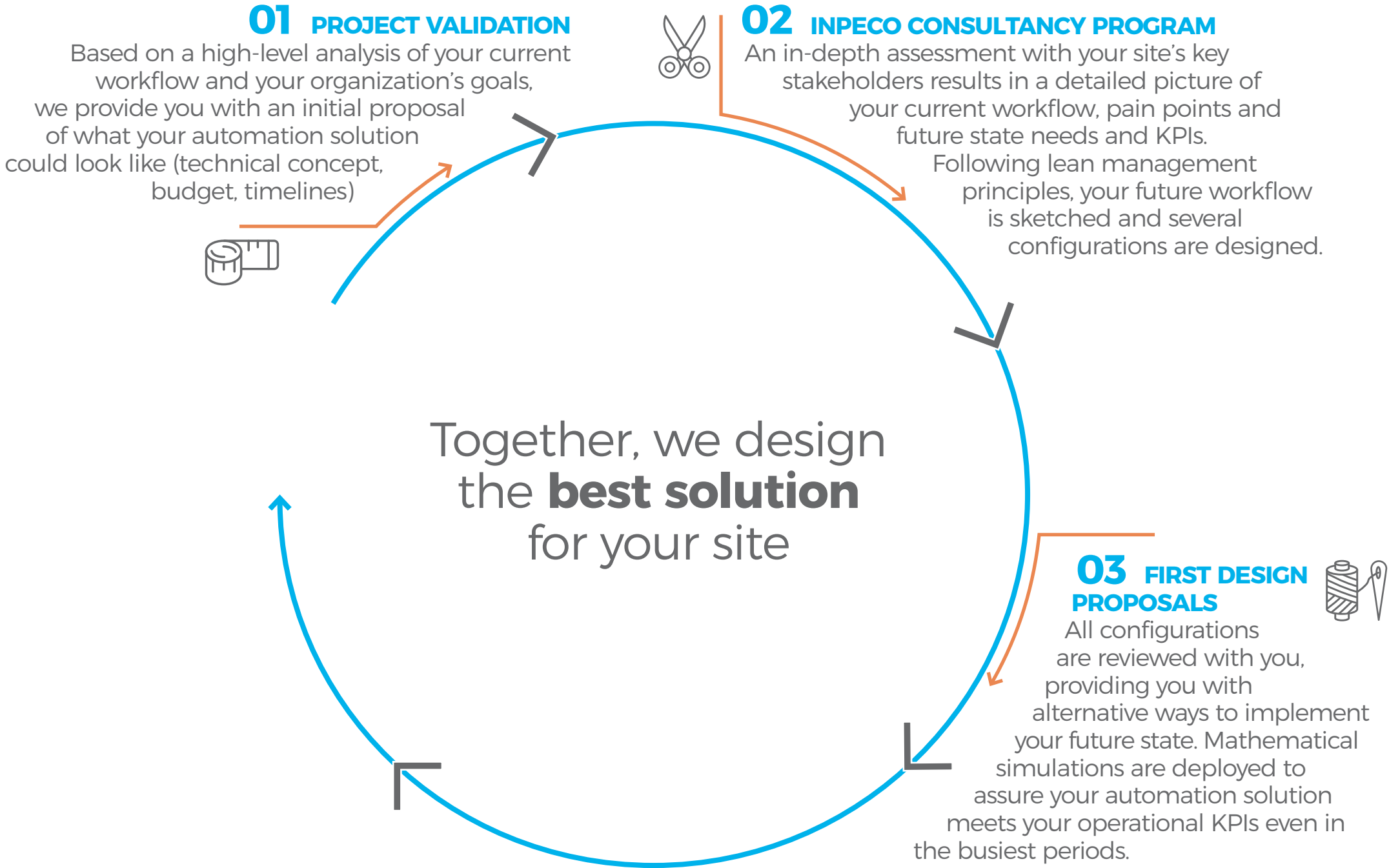

# Project Design: the way to **your tailor-made solution**

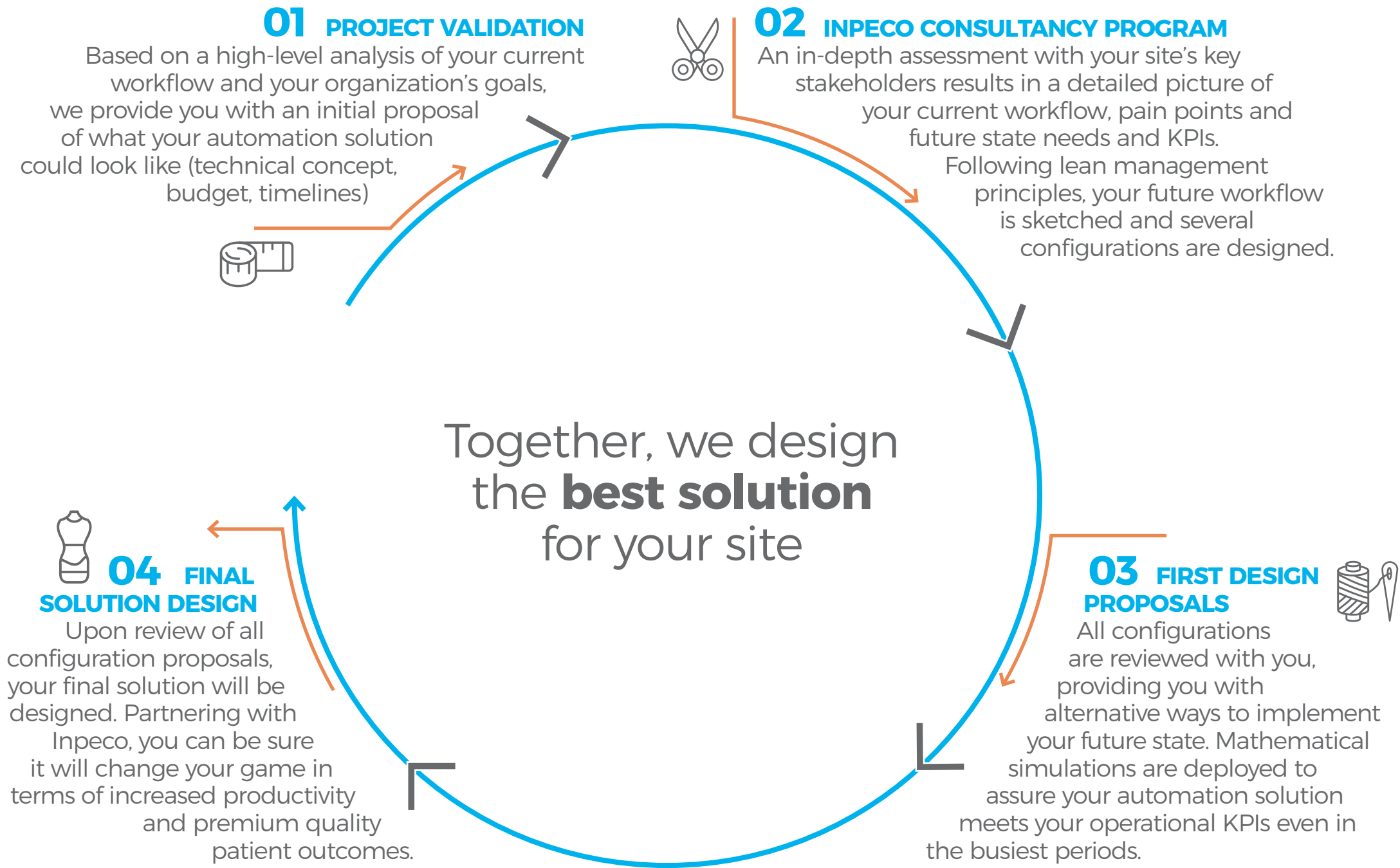





# Touchless workflow. The widest range of components for a **deeply connected automation**

FlexLab™ automation solutions are designed to optimally support the four key steps of the testing process inside the laboratory.

➤ **CHECK-IN AREA**

Various **input modules** designed to fit the accessioning modalities of every lab, including pneumatic transportation. Fully adaptable to workflows used at check-in points, many kinds of tubes accepted.

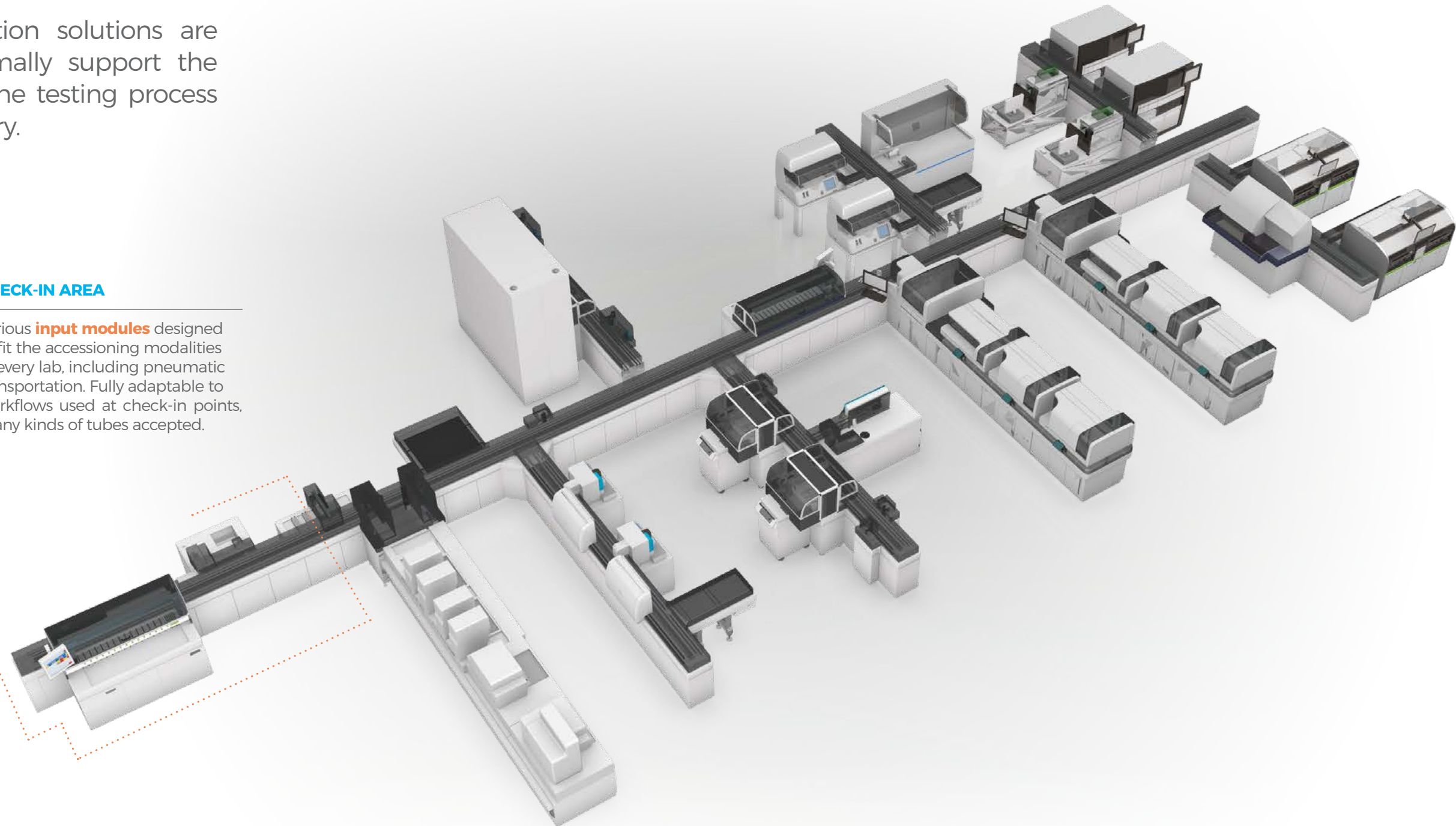





# Touchless workflow. The widest range of components for a **deeply connected automation**

FlexLab™ automation solutions are designed to optimally support the four key steps of the testing process inside the laboratory.



> **CHECK-IN AREA**

Various **input modules** designed to fit the accessioning modalities of every lab, including pneumatic transportation. Fully adaptable to workflows used at check-in points, many kinds of tubes accepted.

> **PRE-ANALYTICAL AREA**

Over **10 modules**, to automate every task in the tube preparation phase. FlexLab™'s powerful software drives every single tube along its most efficient path, stopping it only where needed, and preparing it for the tests in the analyzers assigned.



# Touchless workflow. The widest range of components for a **deeply connected automation**

FlexLab™ automation solutions are designed to optimally support the four key steps of the testing process inside the laboratory.



### CHECK-IN AREA

Various **input modules** designed to fit the accessioning modalities of every lab, including pneumatic transportation. Fully adaptable to workflows used at check-in points, many kinds of tubes accepted.

### PRE-ANALYTICAL AREA

Over **10 modules**, to automate every task in the tube preparation phase. FlexLab™'s powerful software drives every single tube along its most efficient path, stopping it only where needed, and preparing it for the tests in the analyzers assigned.

### ANALYTICAL AREA

FlexLab™ can integrate over **50 different analyzers**, of various manufacturers, covering **11 clinical specialties**. Analyzers can easily be upgraded or changed, as the needs of the laboratory evolve over time.



# FlexLab™

Touchless workflow. The widest range of components for a **deeply connected automation**

FlexLab™ automation solutions are designed to optimally support the four key steps of the testing process inside the laboratory.

## CHECK-IN AREA

Various **input modules** designed to fit the accessioning modalities of every lab, including pneumatic transportation. Fully adaptable to workflows used at check-in points, many kinds of tubes accepted.

## POST- ANALYTICAL AREA

Many post-analytical modules to secure the last steps of the sample journey, including the seamless combination of retrieval/desealer tasks; **100% touchless**. Multiple refrigerated storage solutions, accomodating from 9.000 to 336.000 tubes.

## ANALYTICAL AREA

FlexLab™ can integrate over **50 different analyzers**, of various manufacturers, covering **11 clinical specialties**. Analyzers can easily be upgraded or changed, as the needs of the laboratory evolve over time.

## PRE- ANALYTICAL AREA

Over **10 modules**, to automate every task in the tube preparation phase. FlexLab™'s powerful software drives every single tube along its most efficient path, stopping it only where needed, and preparing it for the tests in the analyzers assigned.

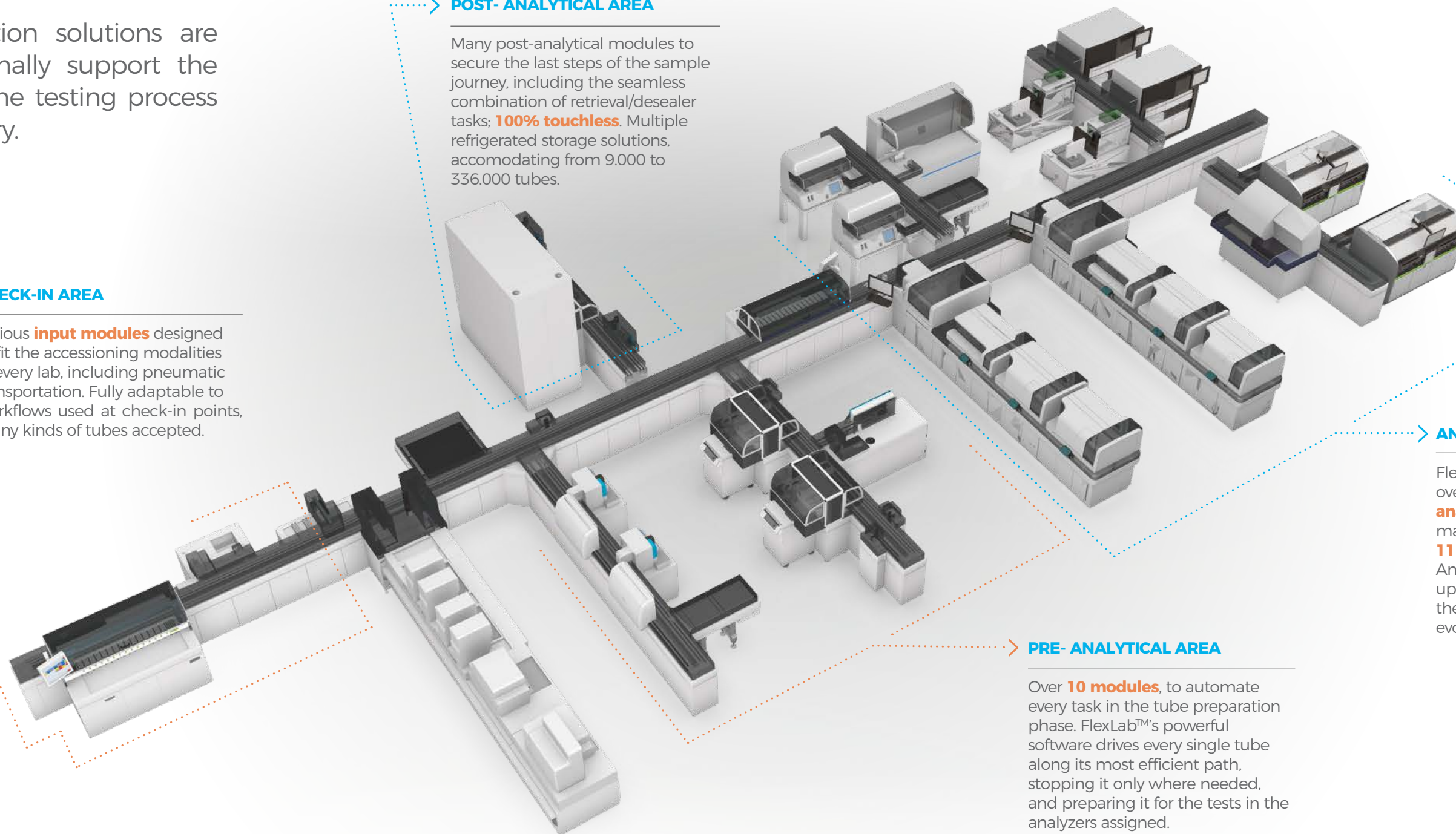

# FlexLab™

Many configurations, to **fit any laboratory.**

“ I’m looking for a complete automation track that lets me connect the analyzers of my choice and allows me to combine different specialties in the core lab.”

## If you:

- ✓ face the daily challenge of delivering results in the committed TAT/in full/ without errors
- ✓ work in close touch with clinicians and patients
- ✓ have to manage sudden peaks and a shortage of personnel

**then you should consider FlexLab™**

## Benefits of FlexLab™

- Reduces loss of tubes and delays in reporting
- Keeps TAT commitments by client
- Records all testing steps for quality checks
- 100% touchless process grants operators' safety
- Many modules for perfect adherence to your footprint

2.000

Tubes/day



4.000

Tubes/day

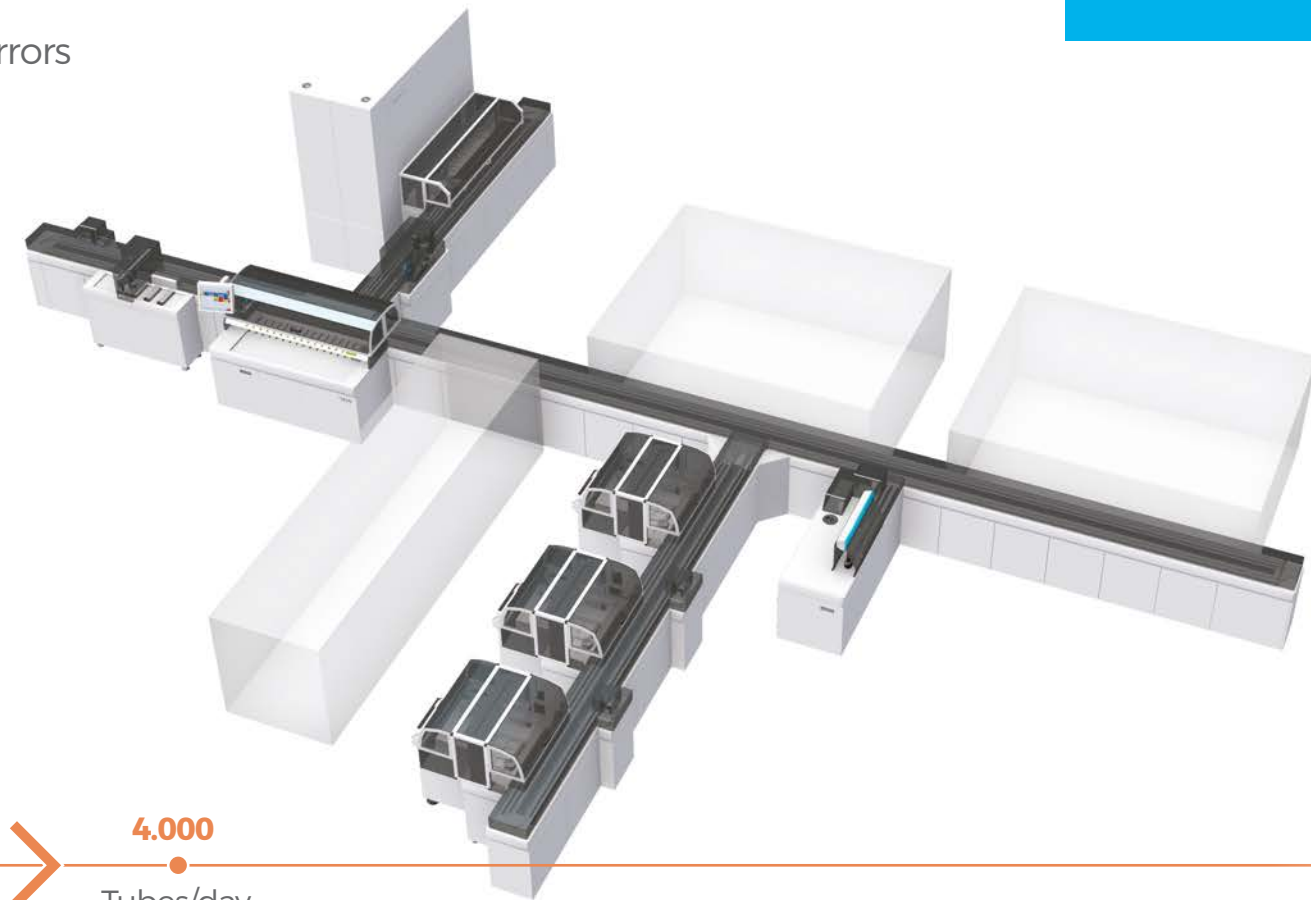

Case

1

- Hospital laboratory
- Patient-centricity
- Diagnosis and research

The **Value**

Complete automation, without compromise.

# FlexLab™

Many configurations, to **fit any laboratory.**

“ I’m looking for an automated track that grants my independence from analyzer manufacturers and grows at the pace of my business. It must make the difference in the service I provide to my network! ”

## If you:

- ✓ process samples from various collection points
- ✓ need to retrieve tubes quickly
- ✓ want to thoroughly monitor the efficiency of your lab

then you should consider FlexLab™

## Benefits of FlexLab™

- Easy-to-use system for operators
- Grants continuous up-time and premium service levels
- Easy sample retrieval for quick reflex requests
- Dashboards for system performance monitoring

10.000  
Tubes/day

20.000  
Tubes/day

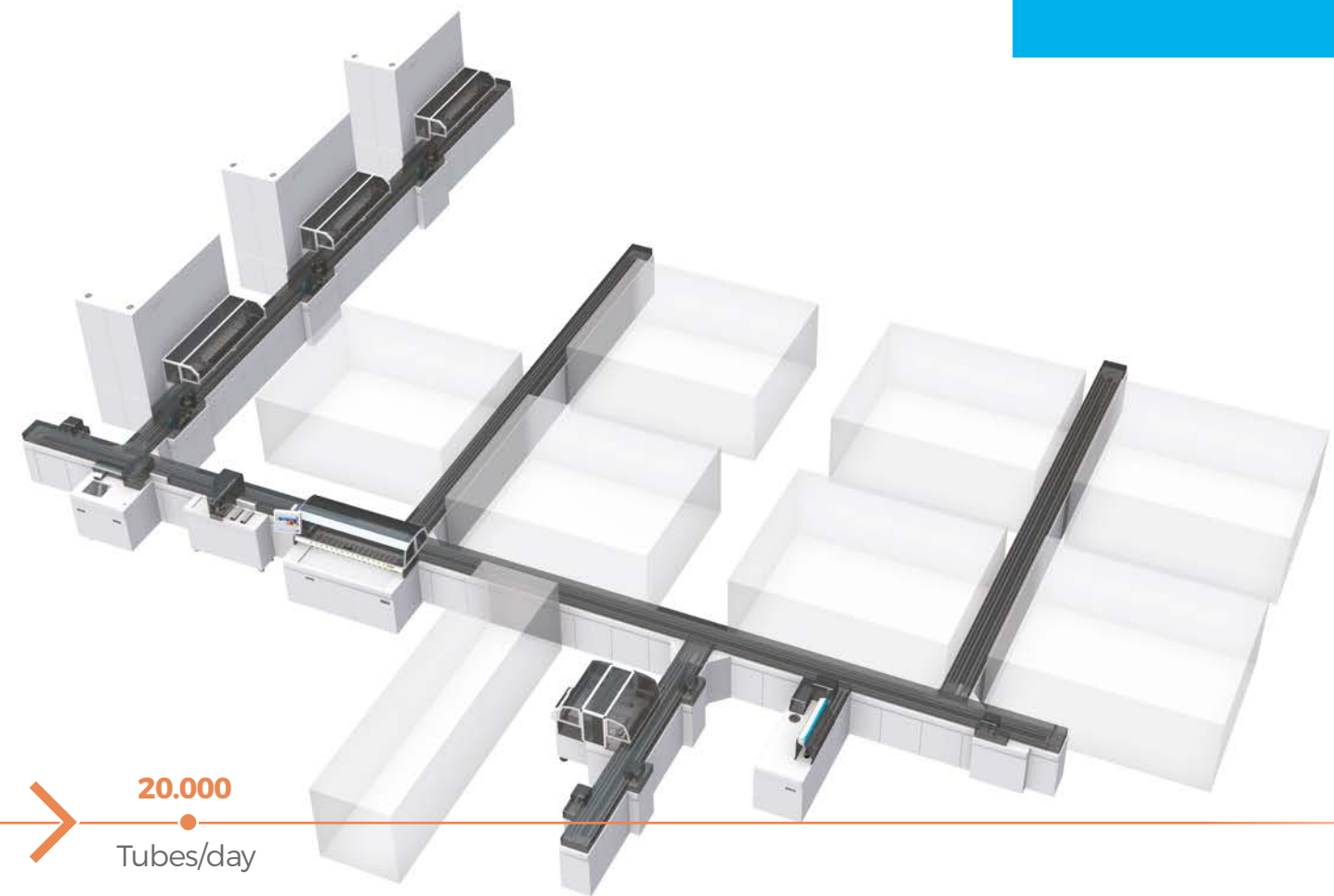

Case

# 2

- Independent laboratory
- Various tubes at check-in
- High throughput workflow

## The Value

Process efficiency with innovative solutions.



# FlexLab™

Many configurations, to **fit any laboratory.**

“ For my enterprise I’m looking for an outstanding automation that allows my service to manage extremely high throughput, to connect a high number of modules and specialties and to easily update the connected systems whenever needed.  
It must make the difference in the service I provide to my network! ”

## If you:

- ✓ daily face operations and logistics challenges
- ✓ are looking for overall system efficiency
- ✓ need to store high volumes of samples

**then you should consider FlexLab™**

## Benefits of FlexLab™

- High Volume Storage modules (up to 336.000 tubes each)
- Real-time monitoring of system efficiency
- Full sample traceability (what/where/when)
- Tailor-made layout design to reduce staff circulation

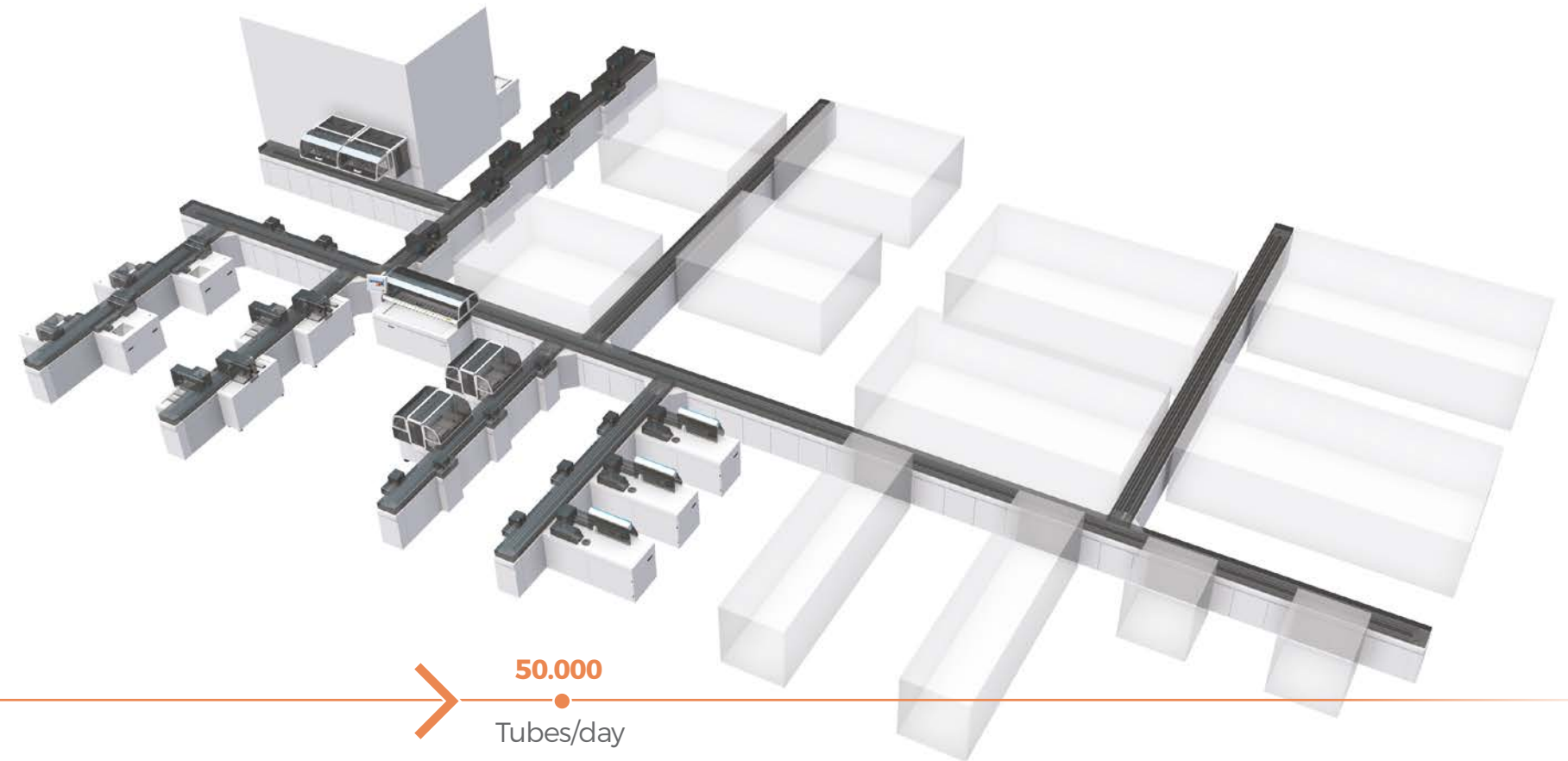

Case

# 3

- Mega Clinical laboratory
- Wide-spread geography of collection centers
- Storage of high sample volumes

## The Value

Full independence with a tailor-made solution.



# FlexLab™

Innovative solutions, for **demanding situations.**

Laboratories sometimes face unique challenges, like a workflow increase due to a consolidation, the expansion of the lab's footprint to other floors or the integration of new specialties in the CoreLab. Being the global leader in healthcare automation, Inpeco has developed innovative modules that cope even with the most demanding situations.

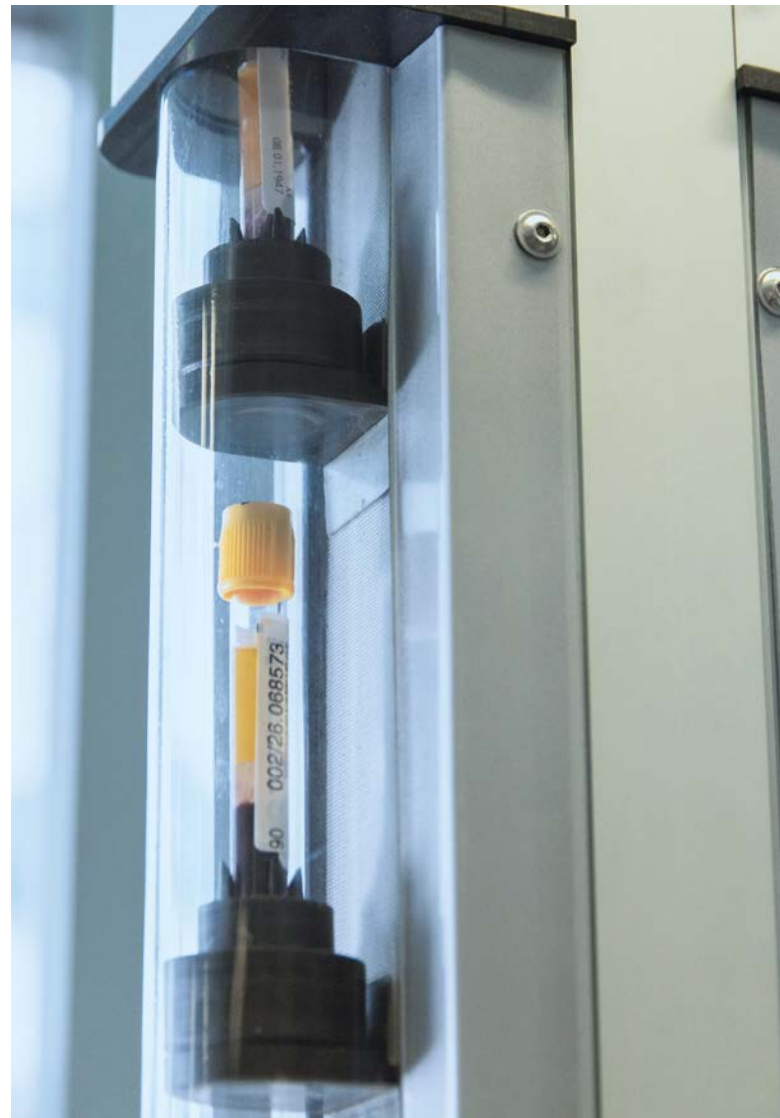

## Vertical Transportation Module\*

It transports the tube to the upper floors, thus integrating the tracks and allowing for a real 3D laboratory expansion.



## High Volume Storage\*

Each module of this storage solution - fully automated with a traslo robot - can accommodate up to 336.000 tubes.

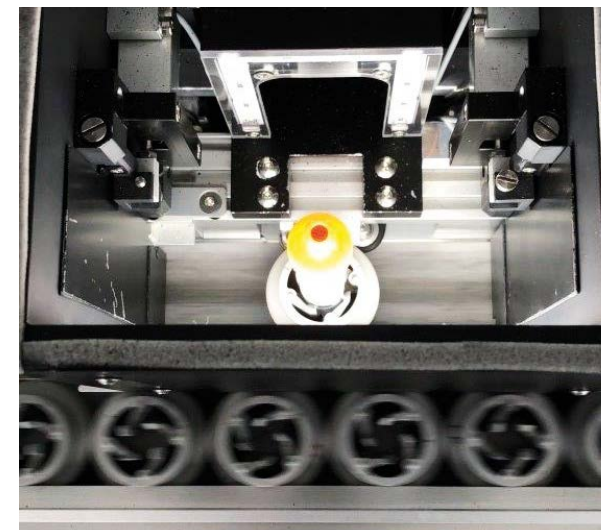

## Sample Integrity\*

The Vision system device for the HIL (Hemolysis, Lipemia, and Icterus) indexes estimation.

\*Only available for some FlexLab models.

# FlexLab™

## Data Analytics System **Workflow management without compromise**

Day in, day out, clinical laboratories generate huge amounts of data. How this data is leveraged greatly influences the quality of your test results and the performance of your facility. **Data Analytics System** transforms your data into actionable information. It allows for real time monitoring of your automation system and assures full sample traceability. Moreover, its customizable reporting dashboards (graphs, KPIs) display TAT, module uptime, system throughput and quality indicators, allowing you to optimize your site's clinical, operational and financial performance.

### Key Features

- Automation Map showing status of modules and instruments connected to the Automation System
- Intuitive KPI dashboards and downloadable reports
- Traceability of single events and the full sample journey

### Benefits

- At a glance monitoring of lab automation performance
- Actionable insights (KPIs) to improve clinical, operational, and financial performance
- Traceable quality test results

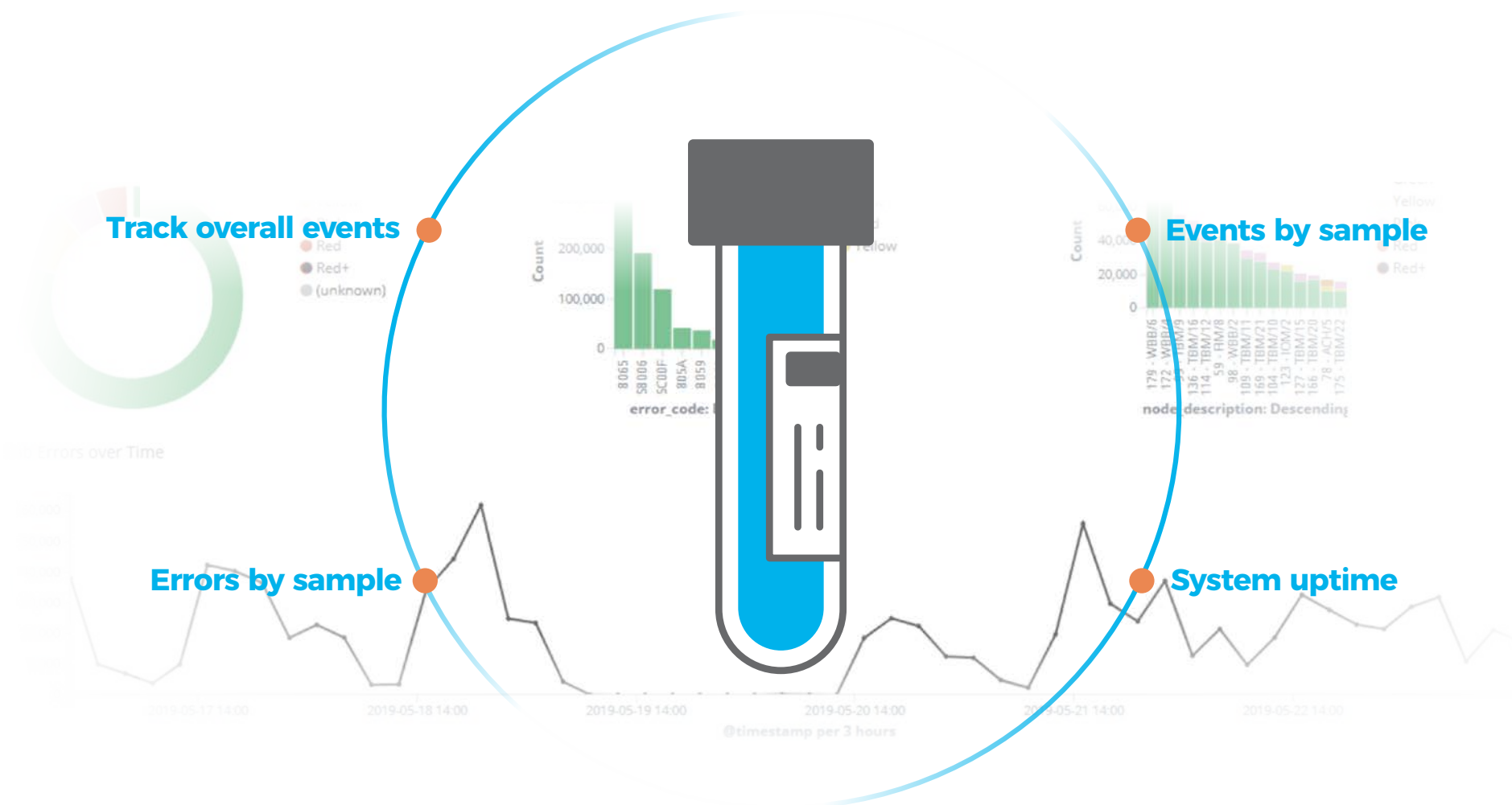

# FlexLab™

Built to **advance the Total Testing Process**

In combination, FlexLab™ and ProTube™ - the Inpeco's automated sample preparation solution - enable **open system automation** with **full sample traceability** across the Total Testing Process - for **validated test results** and **increased productivity**.

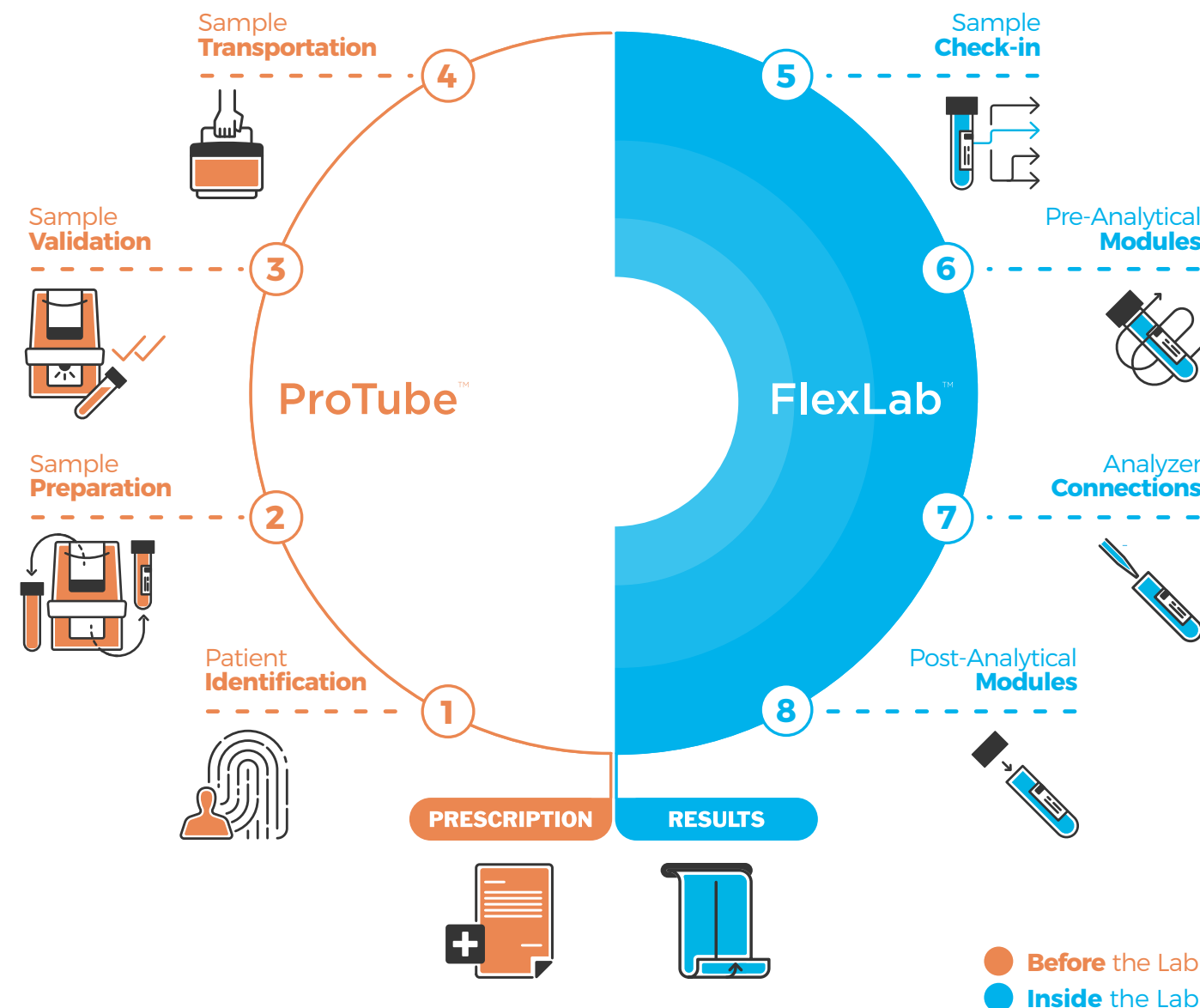

**Inpeco SA**

Via Torraccia 26  
6883 Novazzano  
Switzerland  
inpeco.com



---

reference code: BRO-FLX 0107  
version n°: EN03  
Sept 2022

